

UCAN

FASTENING PRODUCTS

L
V
3
6
0

WARNING!
READ THIS MANUAL
PRIOR TO OPERATING TOOL

OPERATOR'S
INSTRUCTION
MANUAL



SEMI-AUTOMATIC LOW VELOCITY
FASTENING TOOL

UCAN
FASTENING PRODUCTS

Toronto, Ontario M3J 2C6
Tel: 416.631.9400
Fax: 416.631.9426
E-mail: sales@ucanfast.com
Web: www.ucanfast.com

TABLE OF CONTENTS

Tool handling and use	2-3
Limitations of use	3-4
Maintenance	5
Operation	6-7
Assembly	7
How to change the piston and sleeve	8
Cleaning and maintenance	9
Deluxe equipment	10
Parts list and diagram	11-12
Headed fasteners	13
Fastener penetration guide	13
Replacement parts and repair service	13
Training course	14-21
Warranty	22

INTRODUCTION

The LV 360 is designed for speed, convenience, economy and above all... SAFETY. The LV 360 will give many years of service. To ensure consistent, trouble-free operation of the LV 360 and to prevent injury, follow the instructions in this manual for operating, cleaning, and maintaining the tool.

PRIOR TO THE USE OF THIS TOOL, THE OPERATOR SHOULD BE PROPERLY TRAINED BY A QUALIFIED INSTRUCTOR

In this instruction manual you will also find illustrations of the LV 360 as well as information about cartridges, pistons, and spare parts. If you have questions which are not addressed in this manual, or if you have special fastening applications, please contact your nearest UCAN Fastening Products' Distributor.

TOOL FEATURES

Tool length:	13-5/8"	Fastener range up to:	2-1/2 inches
Tool weight:	5 lbs.		10 cartridge magazine with semi-automatic cartridge advance.

TOOL HANDLING & USE

1. Operate tool with powder loads and fasteners specified by the tool manufacturer.
2. Only trained operators may use powder actuated tools.
3. Operate in accordance with the manufacturer's instruction manual provided with each tool.
4. Wear personal protective gear, including goggles, ear plugs and helmet. This applies to the tool operator and bystanders in close proximity to the firing of the tool.
5. Do not use powder actuated tools in explosive or flammable environments.
6. When the powder actuated tool is used in a confined space, ensure area is ventilated.
7. Prior to use, the operator shall inspect the tool as specified in the manual to determine that it is in proper working condition. Tools found not to be in proper working condition shall be serviced in accordance with the manufacturer's instruction manual.
8. If a tool is found to be defective, it shall not be used, but shall be marked "Repair". Makeshift repairs or alterations shall not be made to any tool. Refer to "maintenance" on page 5.
9. When fastening directly into concrete or steel, use the proper stabilizer or guard, suited for the application.

10. Under no circumstances shall a loaded tool be left unattended.
11. Tools, whether loaded or not, must not be pointed at any person.
12. The muzzle of the tool must not be depressed by the palm of the hand.
13. The tool should always be held perpendicular to the work surface while fastening any material, except for special applications recommended by and carried out in accordance with specific practices prescribed by the tool manufacturer.
14. In the event of a misfire, the operator shall continue to hold the tool firmly against the work surface for a period of not less than 15 seconds, after which time the cartridge shall be ejected. The misfired cartridge must be removed from the spent power load strip and disposed of in accordance with local regulations.

LIMITATIONS OF USE

1. Fasteners shall not be driven into very hard or brittle materials including but not limited to cast iron, glazed tile, hardened steel, glass block, natural rock, hollow tile, or some types of brick.
2. When the hardness of a substrate or surface is not known, it shall be tested by using a hand hammer to drive the point of the fasteners into the surface. If a fastener does not easily penetrate, is not blunted, and does not fracture the surface, initial test fastenings shall then be made in accordance with the tool manufacturer's recommendations. If the point of the fastener does not penetrate the surface, no attempt shall be made to use the tool on that surface.
3. Fasteners shall not be driven into easily penetrable or crumbly materials of unknown resistance.
4. Fasteners with a shank diameter of 4.83 mm (0.190 in) or less shall not be driven into concrete:
 - a. at a distance closer than 75mm (3 in) from an unsupported edge, unless written approval from the manufacturer is obtained prior to undertaking this work.
 - b. that is less than 65mm (2-1/2 in) in thickness, or three times the penetration of the fastener shank;
 - c. at a distance less than 75mm (3 in) from where another fastener has failed.

5. Fasteners with a shank diameter of 4.83mm (0.190 in) or less shall not be driven into steel:
 - a. that is less than 4.83mm (3/16 in) in thickness;
 - b. at a distance less than 50mm (2 in) from a weld; and
 - c. at a distance less than 13mm (1/2 in) from the edge.
6. Fasteners with a shank diameter larger than 4.83mm (0.190 in) shall not be driven into steel:
 - a. that is less than 10mm (3/8 in) in thickness;
 - b. at a distance less than 50mm (2 in) from a weld; and
 - c. at a distance less than 13mm (1/2 in) from the edge.
7. Fasteners may be driven into masonry walls (brick or block) but shall not be driven into a corner brick nor a vertical mortar joint.
8. Fasteners shall not be driven directly adjacent to pretensioning or post tensioning tendons.

MAINTENANCE AND STORAGE

1. Clean and lubricate the tool as recommended in the Instruction Manual.
2. Check tools prior to each day's use to ensure they are in proper working order.
3. Replace worn or damaged parts as required.
4. Any tool found not in working order should be immediately removed from service, tagged as "defective" and used again only after being repaired by a qualified individual. Use only repair/replacement parts recommended by the tool manufacturer.
5. Powder actuated tools and cartridges shall be locked in a container and stored in a safe place when not in use. Only authorized personnel, trained to use the tool, should have access.

PROPER MAINTENANCE AND STORAGE OF POWDER ACTUATED TOOLS IS NECESSARY TO ENSURE CONSISTENT, TROUBLE-FREE OPERATION AND HELP PREVENT INJURY.

OPERATION

IMPORTANT: To make successive fastenings, always insert the fastener before advancing magazine as in illustrations 1 & 2. Overdriving due to using too strong a cartridge, too short a fastener, or too little resistance in the base material can result in deformation of the shear clip. If this should occur, the shear clip must be replaced. Always completely remove the magazine before disassembly or cleaning of the tool. The magazine must always be removed from the top of the tool - never from the handgrip. Your LV360 must always be unloaded before:

- changing any parts (piston, piston sleeve, etc.)
- taking a work break - servicing and cleaning
- storing at the end of the work day.

After removing each magazine, the breech must be inspected for foreign particles.

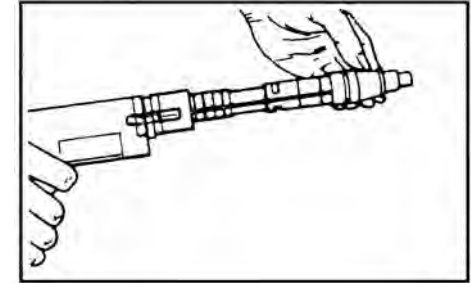
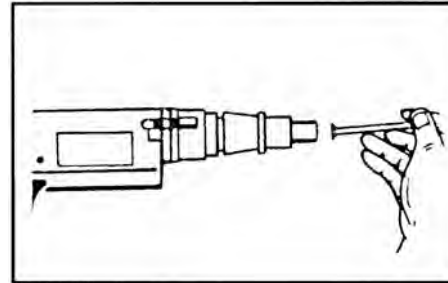

1. With the point out, insert fastener into the guide until it is held in place by the plastic washer.
2. In one movement, pull out the baseplate and piston sleeve to the stop, then push back again to the stop.
- 2a. If the movement is stiff, lightly spray the outer surface of the piston sleeve with lubricant and slide in and out several times.

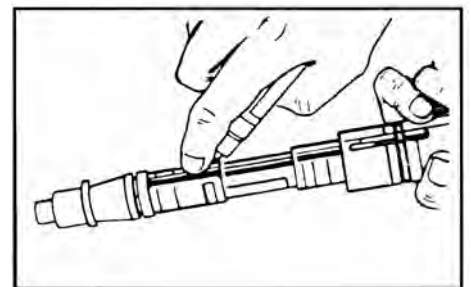
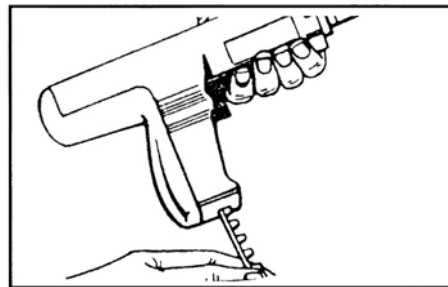

3. Insert the magazine into the base of the handgrip. Slide the magazine upwards until it is flush with the bottom of the grip. Always insert magazine from the bottom of the tool.
4. Press tool firmly and squarely against the work surface and squeeze trigger.

NOTE: Tool must be perpendicular to work surface for best fastening results.

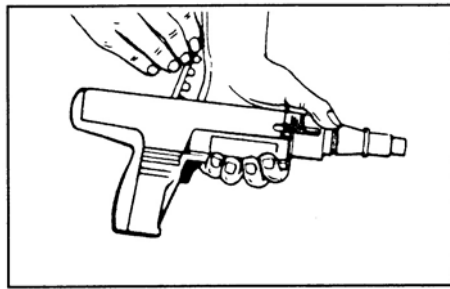
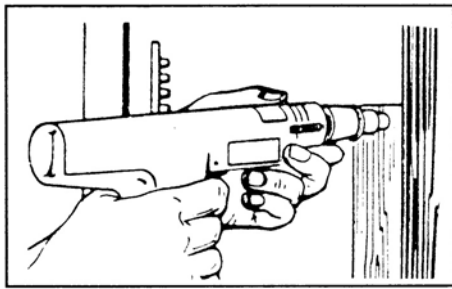

- Repeat steps 1, 2 and 4 until the cartridge magazine has been exhausted (ten fastenings). To remove the magazine, slide the base plate forward and pull the strip out from the top of the tool body. While doing so, do not point the tool at anyone and keep your hands away from the front of the tool. During firing operation, keep hands clear of both top and bottom booster chamber openings.

ASSEMBLY

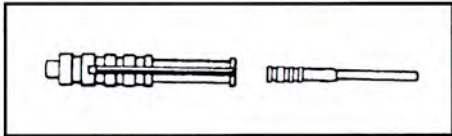

- Push the piston into the end of the piston sleeve.

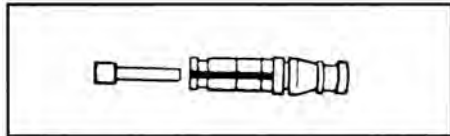

- Insert the guide into the baseplate.

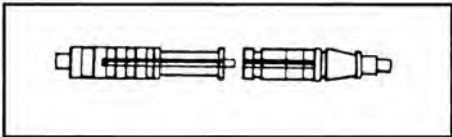

- Slide the baseplate and guide assembly onto the piston sleeve....

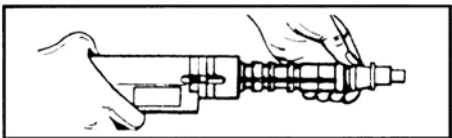

- Insert the front sleeve assembly into the steel liner of the tool body.

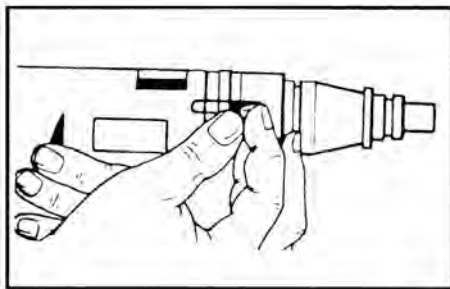

- Replace the stop and rotate opening for the stop.

NOTE: The sleeve groove in the piston sleeve/baseplate assembly must be aligned with the opening for the stop.

HOW TO CHANGE THE PISTON AND SLEEVE

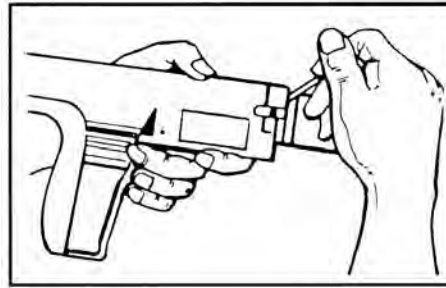

- Lift the end of the annular spring and rotate toward top of tool. Pull the stop back and outward to remove.

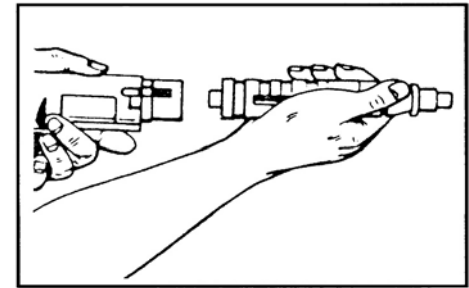

- Slide out the complete operating assembly.

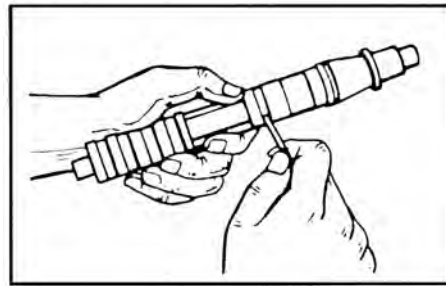

- Pry off the shear clip with the point of the fastener. If the shear clip is damaged, it must be replaced.

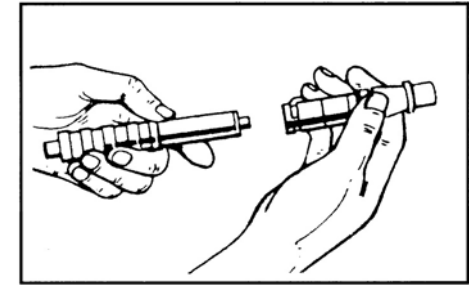

- Separate the baseplate and guide from the piston sleeve.

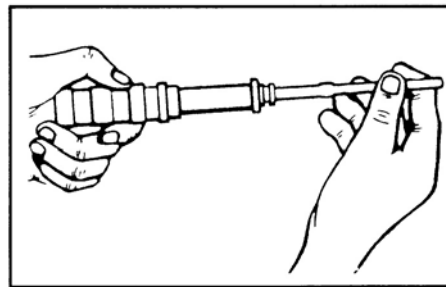

- Pull the piston out of the piston sleeve.

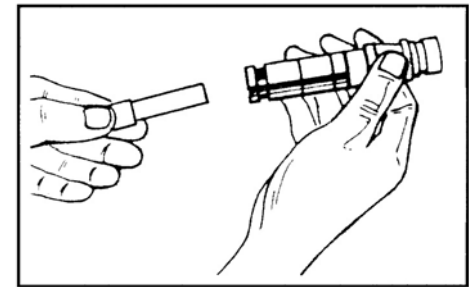

- Incline the baseplate and the guide will slide out.

NOTE: If the guide does not slide out freely, push it out of the baseplate with a piston.

CLEANING AND MAINTENANCE

Clean the parts and surfaces with the supplied brushes.

NOTE: ALWAYS clean the tool daily or after approximately 1,000 firings.

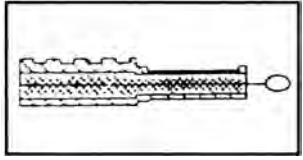

Piston Sleeve
Internally and Externally

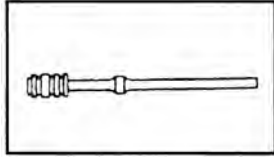

Piston
Externally

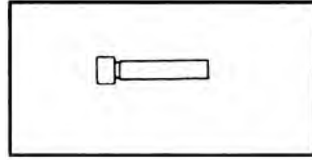

Guide
Internally and Externally

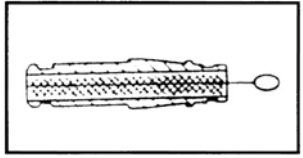

Baseplate
Internally and Externally

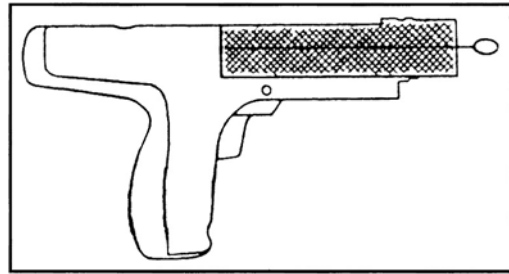

Steel Liner
Internally

Spray all parts with lubricant and wipe off excess before reassembling.

NOTE: DO NOT SPRAY the inside of the steel liner or magazine chamber on the piston sleeve.

DELUXE EQUIPMENT

Deluxe kit includes:



LV360



Carrying Case

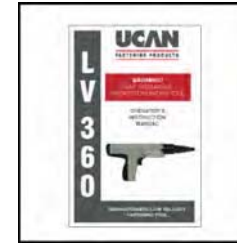

Manual



Cleaning cloth



Cleaning brushes



Lubricant spray



Ear Plugs
(Disposable)

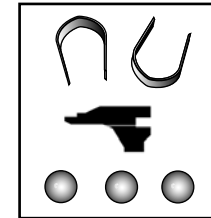

Spare Parts



Safety Goggles

UCAN Fastening Products provides a set of disposable sample ear plugs with each tool. These are not intended as permanent ear protection.

Parts may not be exactly as shown.

LV-360 PARTS KIT

Item	Description	Part No.	Item	Description	Part No.
1	Body	301001	24	Firing Pin Assembly	301400
2	Pin, Trigger	301034	25	Spring Holder	301420
3	Holder, Advance Bar	301529	26	Spring	301421
4	Advance Bar	301530	27	Nut	301422
5	Spring, Advance Bar	301531	28	Spring, Sear Holder	301026
6	Trigger	301533	29	Spring, Firing Pin	301025
7	Bolt	301015	30	Plug	301028
8	Liner	301100	31	Rubber Pad Assy.	301600
9	Annular Spring	301014	32	Rock Arm	301844
10	Ball	301013	33	Spring	301840
11	Stop	301012	34	Spring	301843
12	Push Pin	301016	35	Pin, Rock Arm	301845
13	Ball	301046	36	Bushing	301532
14	Spring	301047			
15	Piston Sleeve	301006			
16	Piston Flat	301200			
17	Piston Ring	301208			
18	Guide	301010			
19	Baseplate	301009			
20	Shear Clip	301011			
21	Sear Holder	301300			
22	Sear	301023			
23	Spring, Sear	301024			

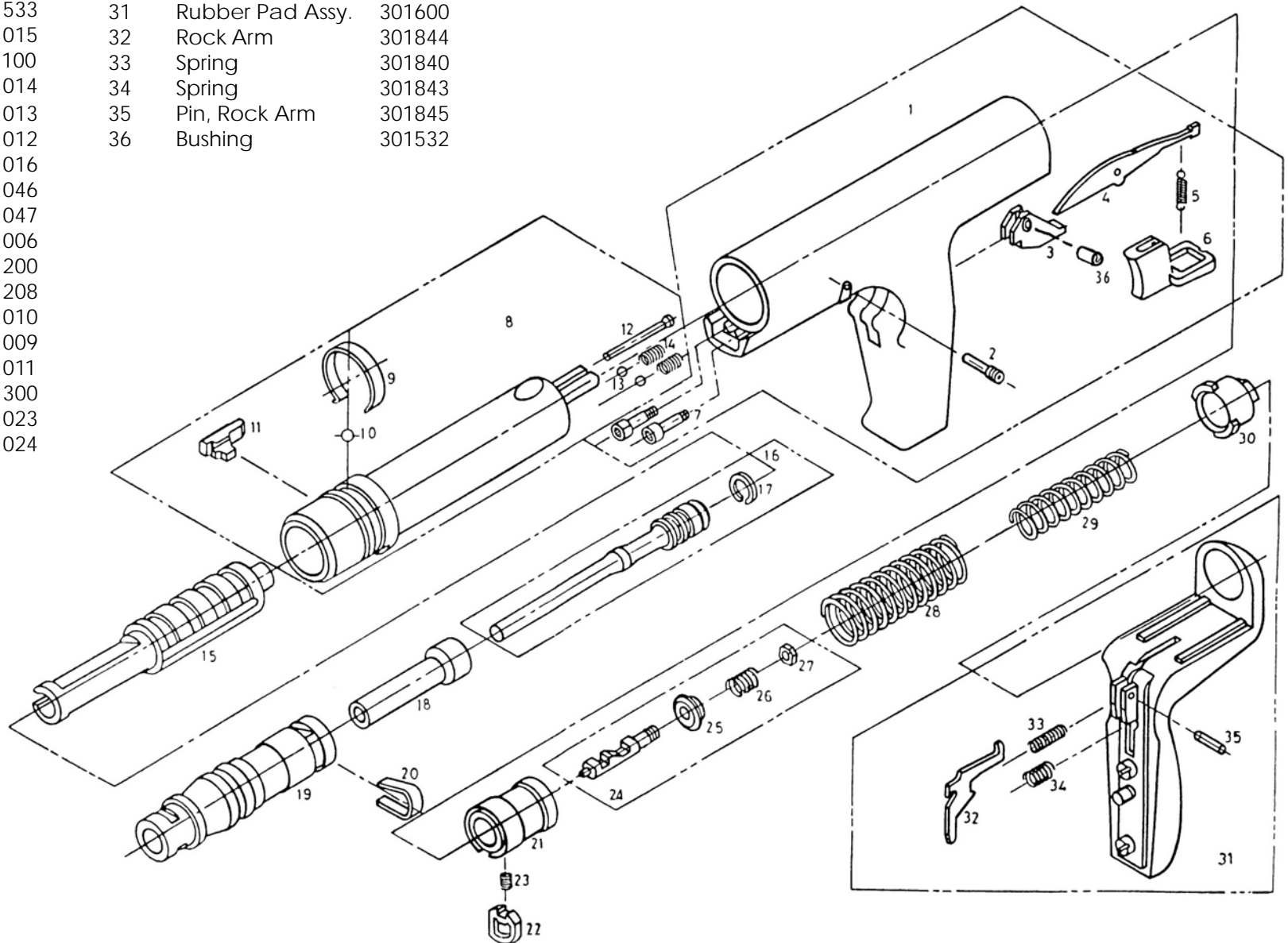

**.300 FLAT-HEADED FASTENERS
5/16" FLUTED GUIDE WASHERS**

AFH 19 (3/4")	AFH 47 (1-7/8")
AFH 25 (1")	AFH 57 (2-1/4")
AFH 32 (1-1/4")	AFH 62 (2-1/2")
AFH 37 (1-1/2")	AFH 72 (3")



Knurled for Steel

SUPER POINT PINS

AFH 13K (1/2")	ASB 13 (1/2")	ASB 19 (3/4")	ASB 32 (1-1/4")
	ASB 16 (5/8")	ASB 22 (7/8")	ASB 47 (1-7/8")

1/4-20 THREADED STUDS

U-14-20/12K	3/4"	1/2"
U-14-20/25	3/4"	1"



CARTRIDGES .27 Calibre Strip

In strips of 10 cartridges each:



Description	Power level	Part# (100)
Green	3 light	CHS G
Yellow	4 medium	CHS Y
Red	5 heavy	CHS R

FASTENER PENETRATION GUIDE

Soft masonry	Cinder-concrete block, etc	1-1/2" penetration
Avg. concrete	Poured concrete, etc	1" penetration
Dense concrete	Pre-stressed/pre-cast concrete	3/4" penetration
Steel	Structural steel, etc	1/2" penetration

REPLACEMENT PARTS AND REPAIR SERVICE

Your UCAN Powder Actuated Tool is precision engineered for safety. NEVER attempt to modify parts since this can compromise the built-in safety. When servicing, use only UCAN replacement parts. Replacement parts are available through your local UCAN Fastening Products' Distributor. If your tool requires service or warranty repairs, contact a UCAN Distributor, who will determine whether the tool is field repairable or must be forwarded to a repair center.

Owners of UCAN Tools are assured of excellent service wherever they may be. Contact your nearest UCAN Distributor or our Technical Marketing Services Department for assistance with fastening applications, tool maintenance, or operator instruction for "safe tool use".

UCAN FASTENING PRODUCTS

**OPERATOR'S TRAINING COURSE FOR THE LV 360
POWDER ACTUATED TOOL AND FASTENERS**

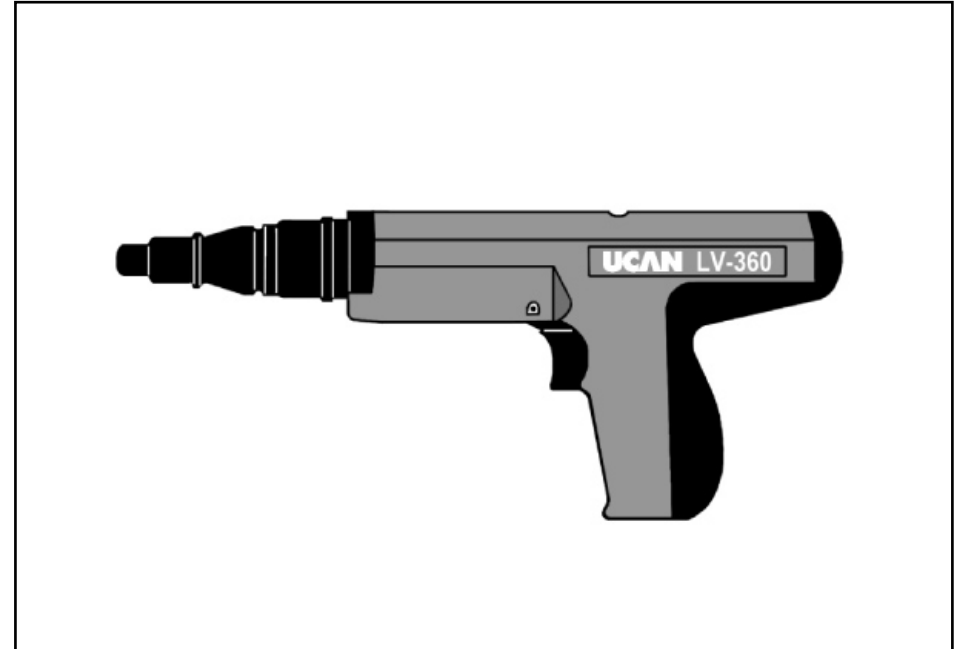

NOTE: Review of this general training course is required to become a qualified operator of UCAN Fastening Products Powder Actuated Tools. Review of the individual tool instruction manuals, as well as hands on instructions on the operation and maintenance of the specific tools are required prior to using a Powder Actuated Tool.

I. POWDER ACTUATED FASTENING SYSTEMS

Powder actuated fastening systems provide a means to make direct, forced entry fastenings into a variety of base materials for construction and maintenance applications. The system consists of a tool; a fastener; and a power load or cartridge. The qualified operator is the key to safe, efficient use of the system and therefore must be trained and licensed according to UCAN Fastening Products standards and procedures. The qualified operator must also follow any local regulations that apply to the use of the powder actuated fastening systems.

II. POWDER ACTUATED TOOLS

There are two types of powder actuated tools:

1. Direct acting tools operate by the action of the expanding gas of the cartridge acting directly on the fastener to drive it into the work surface.

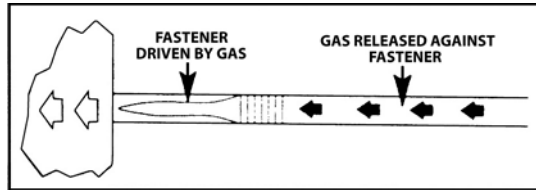

2. Indirect acting tools have a captive piston which is driven by the expanding cartridge gas. The piston then drives the fastener into the work surface.

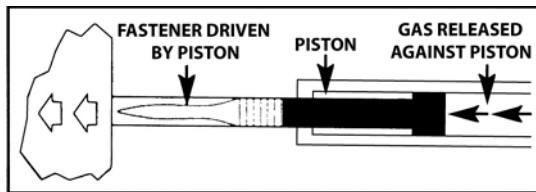

There are three velocity classes of powder actuated tools. The velocity class of the tool is determined by a ballistic test utilizing the lightest fastener and the strongest cartridge which is designated for use with the tool by the manufacturer.

- A. High velocity class - A tool produces an average test velocity over 150 meters (492 feet) per second.
- B. Medium velocity class - A tool which produces an average test velocity greater than 100 meters (328 feet) per second, but not exceeding 150 meters (492 feet) per second.
- C. Low velocity class - A tool which produces an average test velocity which does not exceed 100 meters (328 feet) per second.

UCAN Fastening Products LV Powder Actuated Tools are indirect-acting tools which conform to the requirements for low velocity class tools.

III. SHIELDS AND SPECIAL FIXTURES

Use of a shield/stabilizer is recommended when fastening directly into base material (e.g. when installing threaded studs).

IV. FASTENERS

Fasteners used in powder actuated fastening systems are manufactured from special steels and heat treated by a special process which insures that they are hard enough to drive into concrete and steel yet are not brittle. The fact that the fasteners are ductile (not brittle) permits them to be driven into concrete or steel without shattering or breaking during normal applications. Powder actuated fasteners normally have a plastic or metal washer or eyelet around the shank. These devices perform two functions:

1. Assist in holding the fastener in the tool prior to driving it into the work surface.
2. To provide alignment and guidance for the fastener during the driving process.

The most common fastener used with powder actuated tools is the drive pin. The drive pin makes a permanent fastening (ie., the material that you are fastening to the base material cannot normally be removed without damage to the material or the base material.)

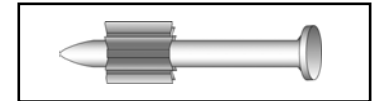

The threaded stud fastener is comprised of a shank portion which is driven into the base material and a threaded portion onto which a nut is inserted. This type of fastener is used for semi-permanent fastening where the material to be fastened to the base material has a pre-drilled hole or slot and is inserted over the threaded stud (after it is driven), then fastened down with the nut and washer combination.

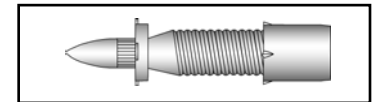

There are also other specialty fasteners made for powder actuated applications such as eye pins; conduit clips; ceiling clips; etc., designed to make certain trade applications easier. In addition, large diameter metal washers are sometimes assembled to drive pins and provide more bearing surface to accommodate fastening of insulations, sill plates (where required by local codes), etc.

NOTE: Remember that P.A.T. fasteners are made of special steel and heat treated especially for these applications. Under no circumstances should fasteners other than those recommended by the tool manufacturer be used in the tool.

V. POWER LOADS/CARTRIDGES

The power load or cartridges is the energy source used in powder actuated tools. UCAN Fastening Products' cartridges are rim fire, cased power loads. Rim fire means that the power load is fired if the load is hit on the rim (outer edge) hard enough by the firing pin. The cartridges may also fire if enough pressure is applied to the rim. This is the reason that cartridges should be pried loose from the tool (or magazine strip).

UCAN Fastening Products' powder actuated tools use power loads which are inserted into the tool either individually or in a strip magazine which contains 10 cartridges. The UCAN LV360 uses .27 caliber loads in strip magazines.

All powder actuated tool power loads are colour coded to identify and differentiate power levels.

In addition, the packages that contain the power loads have a visual colour and number identification. To avoid any confusion, power loads of different power levels and types must be kept in separate containers or compartments.

In the event that the operator is colour blind; the number identification on the package will assist in power level identification. Operators who are unable to distinguish the colours used must be given special instructions to enable them to avoid error.

UCAN Fastening Products' tools use the following power levels:

POWER LEVEL	CASE COLOUR	LOAD COLOUR
#3	Brass	Green
#4	Brass	Yellow
#5	Brass	Red

NOT ALL POWER LEVELS CAN BE USED IN EACH TOOL.

Under no condition should a power load other than those recommended in the Tool Instruction Manual be used with a powder actuated tool.

To determine the correct power level for any application, always start with the lowest level (#3 green for UCAN P.A.T. Tools) cartridge recommended for use with the tool. If the lowest power level cartridge does not achieve the desired level of fastener penetration, continue increasing the power level by single steps until proper penetration is achieved.

In the event of a misfire, the operator shall continue to hold the tool firmly against the work surface for a period of not less than 15 seconds and then the cartridge shall be ejected. The misfired cartridge must be removed from the spent power loadstrip and disposed of in accordance with local regulations.

VI. BASE MATERIALS

The material into which the fastener shank is driven and from which the holding power is obtained is known as the base material. Concrete and structural steel are the two most common base materials into which powder actuated fasteners are driven. When penetrated by a P.A.T. fastener, a suitable base material will expand and/or compress around the fastener and have sufficient hardness and thickness to produce sufficient holding power and not allow the fastener to pass completely through.

Unsuitable base materials will be:

1. Too hard for the fastener to penetrate (hardened steel, welds, cast steel, marble, natural rock, etc.).
2. Too soft for the fastener to penetrate without cracking or shattering the base material (glass, glazed tile, brick, slate, etc.).
3. Too soft for the fastener to produce sufficient holding power or to keep the fastener from passing completely through the base material (wood, plaster, drywall, composition board, etc.).

To determine the suitability of any base material, a center punch test should be performed prior to making any fastenings.

CENTER PUNCH TEST PROCEDURES

Use a hammer and firmly tap a P.A.T. fastener into the base material:

1. If the base material shows a clear fastener point and the fastener is not blunted, then proceed with the first test fastening.
2. If the fastener point is blunted, then the material is too hard.
3. If the base material cracks or shatters, the material is too brittle.
4. If the fastener sinks into the material with an average hammer blow, the base material is too soft.

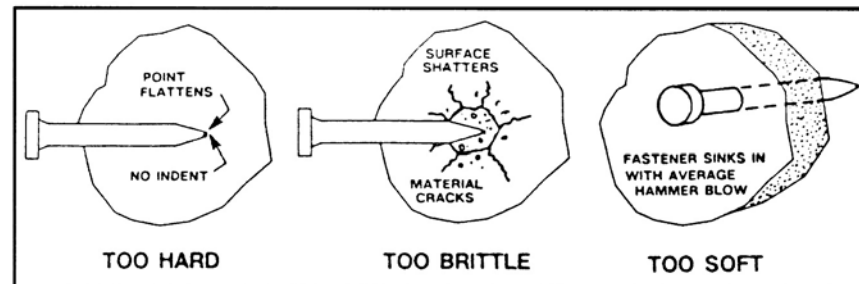

VII. APPLICATION RULES - WARNINGS

For Concrete.....

1. Do not fasten into cracks or spalled areas as this weakens holding power.
2. Concrete must be at least three times thicker than the depth of penetration of the fastener.
3. Do not fasten closer than 3" from an unsupported edge of masonry.
4. Recommended minimum distance between fastenings is 3" in concrete.
5. Average required depth of penetration of fasteners into concrete is:
 - > 1-1/2" in light weight concrete (less than 2000 PSI), block, etc.
 - > 1" in average weight concrete.
 - > 3/4" in hard concrete (5000 to 6000 PSI).
6. Concrete with a compressive strength over 8400 PSI is not normally suitable for fastening with powder actuated fasteners.

For Steel.....

1. Do not fasten into steel thinner than the shank diameter of the fastener.
2. Do not fasten closer than 1/2" from the edge of steel.
3. Recommended minimum distance between fastenings is 1" in steel.
4. Do not use fasteners with shanks longer than required for the application.
5. Average depth of penetration for structural steel is 3/16" to 1/2".
6. To achieve maximum holding power in steel plate: Get the fastener point all the way through the plate. This prevents the steel from compressing around the point and causing fastener back-out.
7. Do not fasten into pre-drilled holes (unless the tool is equipped with a positive alignment device) because the fastener may be deflected by the edge of the hole.

VII. APPLICATION RULES - WARNINGS cont'd...

NOTE: To determine the correct length of drive pin for a particular application, add the thickness of the material to be fastened and the required depth of penetration into the base material.

EXAMPLE: You want to fasten a 2 x 4 board (1-1/2" thick) to average strength concrete. The recommended depth of penetration is 1" - Hence, you would normally use a 2-1/2" drive pin.

To determine the correct size of a threaded stud, the shank length is determined by the required penetration into the base material as you are normally driving a threaded stud directly into the base material. The length of the threaded portion required is determined by the thickness of the material that you are going to insert over the threaded stud and fasten down. Remember that the threads must protrude through the material to be fastened far enough to allow for full thread engagement of the nut or nut/washer combination.

**FAILURE TO FOLLOW THESE APPLICATION RULES MAY RESULT
IN POOR FASTENING AND/OR COULD RESULT IN DEATH OR
SERIOUS INJURY TO THE OPERATOR.**

VIII. GENERAL SAFETY RULES

1. Do not use P.A.T. tools in explosive or flammable environments.
2. Never leave a P.A.T. tool unattended in a place where it would be available to unauthorized personnel.
3. A warning sign (8" x 10" with 1" letters min.) must be posted in plain sight in areas where P.A.T. tools are being used as adjacent areas where wall, floor, or work surface penetration by the fastener by pose a hazard. The wording on the sign should be similar to "Powder Actuated Tools in Use".
4. Operators and co-workers should always wear safety goggles, ear and head protection when powder actuated tools are in use.
5. Always maintain good balance when working on ladders, scaffolds, etc.
6. Never load the tool until ready to make a fastening. When using a tool that uses multiple booster strips, always insert the fastener into the tool prior to advancing to a "live" cartridge.
7. Always operate the tool at right angles to the work surface (to minimize the chance of the fastener deflecting off the work surface).
9. Never carry fasteners or other sharp objects in the same pocket or apron section with power loads as they may strike the cartridge and cause it to fire.
10. Only operators who are trained for a specific P.A.T. tool are allowed to use that P.A.T. tool. The fact that an operator is qualified by another P.A.T. tool manufacturer does not mean that he is authorized to operate a UCAN Fastening Products' tool. An operator must be trained for each tool he uses, even though he may already be trained for another P.A.T. tool made by the same manufacturer.

W A R N I N G
FAILURE TO FOLLOW THESE SAFETY RULES MAY RESULT
IN DEATH OR SERIOUS INJURY

WARRANTY

This new fastening tool is a quality product of UCAN Fastening Products. It has been developed through study and research into the fastening methods and applications of the building industry and associated trades. Every reasonable precaution has been taken in the manufacturing of this tool to assure its compliance with UCAN Fastening Products' standards of high quality. Consultation on the operation and maintenance of the tool is available from your local UCAN Fastening Products' Distributor.

ONE YEAR LIMITED WARRANTY: For 1 year from the date of shipment, the original purchaser of the tool will not be charged for the parts and labour required to correct defects in materials and workmanship, provided the tool is returned to a UCAN Fastening Products Distributor for servicing and inspection, the serial number has not been removed or defaced, only UCAN compatible consumables and parts have been used with the tool, and no unauthorized servicing has been performed. The warranty does not cover normal wear and tear and the cost of shipping and insurance.

THIS IS THE ONLY WARRANTY AND GUARANTEE MADE BY UCAN FASTENING PRODUCTS, AND IT IS GIVEN IN LIEU OF ALL OTHER (EXPRESSED OR IMPLIED) WARRANTIES INCLUDING IMPLIED WARRANTIES OF MERCHANTABILITY AND OF FITNESS FOR A PARTICULAR PURPOSE. Under no circumstances will UCAN Fastening Products be obligated for incidental or consequential damages, losses, or expenses in connection with, or by reason of, or inability to use the tool for any purpose.